

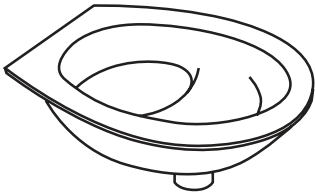

TROBOLO®

User manual
Nutzungsanleitung
Guide d'utilisation

MAN.T2XX1370



U6GXX1358

Insert for urine-diverting toilets

Trenntoiletten Einsatz

Séparateur



BFXX1319

Solids container 22 litres

Feststoffbehälter 22 Liter

Bac à matières solides 22 L



BFSXX1320

Solids container 11 litres

Feststoffbehälter 11 Liter

Bac à matières solides 11 L

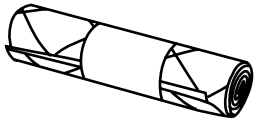

IMXX1328

Compostable inlays

Kompostierbare Inlays

Sacs compostables

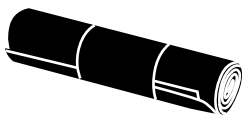

IKXX1327

Inlays made of recycled plastic

Inlays aus recyceltem Kunststoff

Sacs en plastique recyclés



SRXX1340

Cleaning set

Reinigungsset

Kit de nettoyage



U6AXX1360

Adapter system filter sieve

Adapter-System Filtersieb

Système de raccord avec tamis filtrant

Adapter installation

Adapter-Montage / Installation adaptateur

1

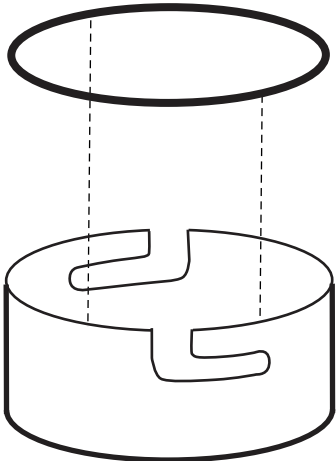

U6AXX1360

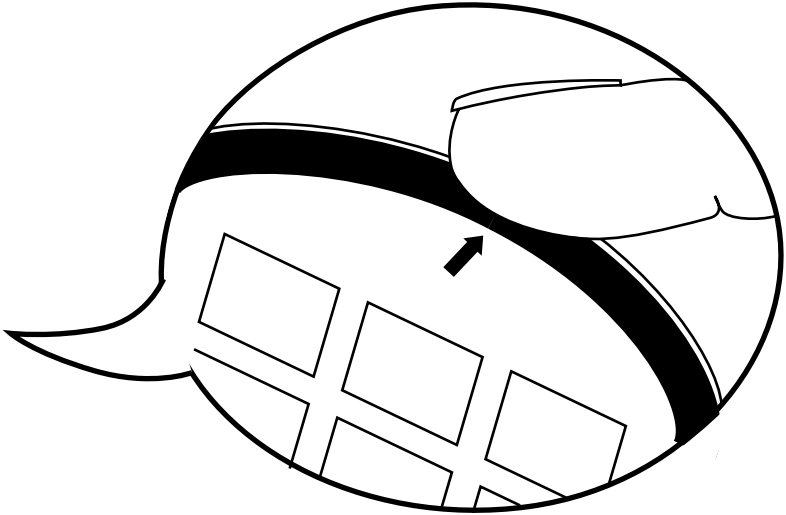

2

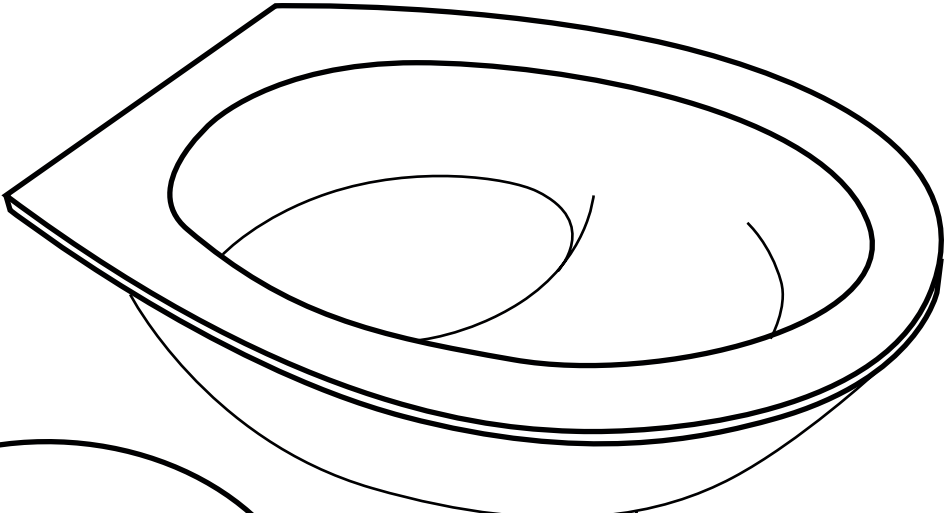

U6GXX1358

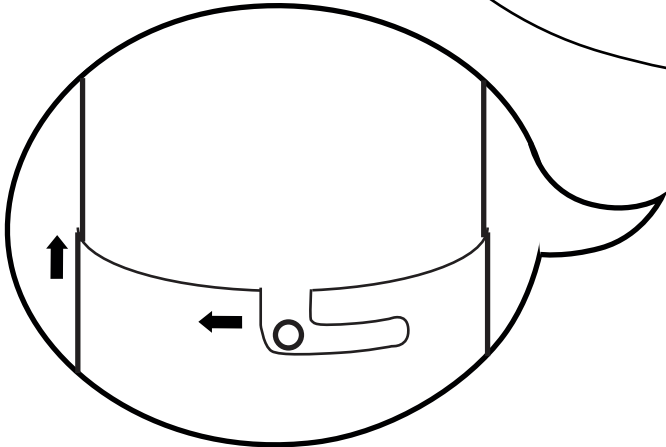

Preparation for use

Inbetriebnahme / Mise en service

1

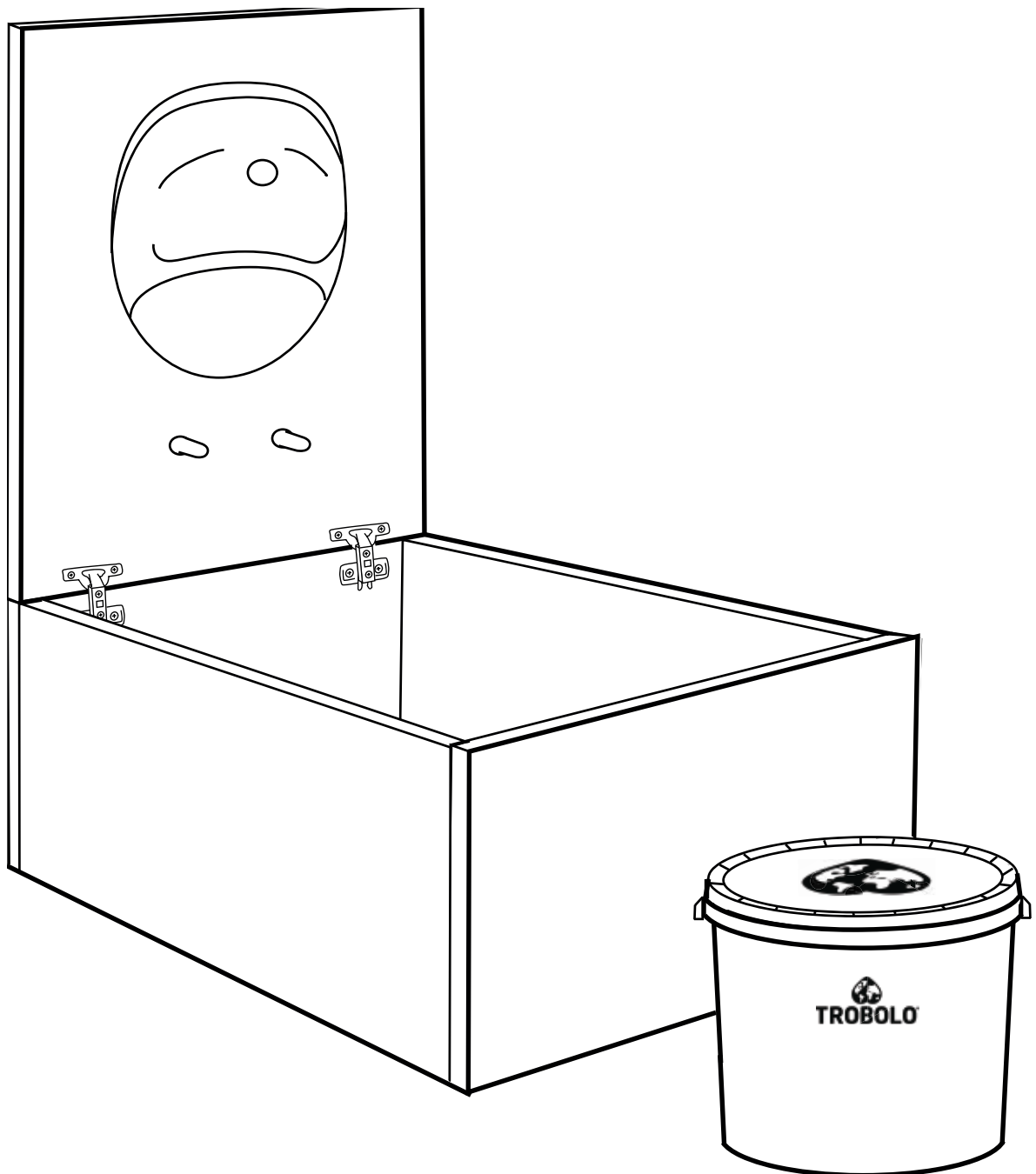

BFXX1319 / BFSXX1320

2

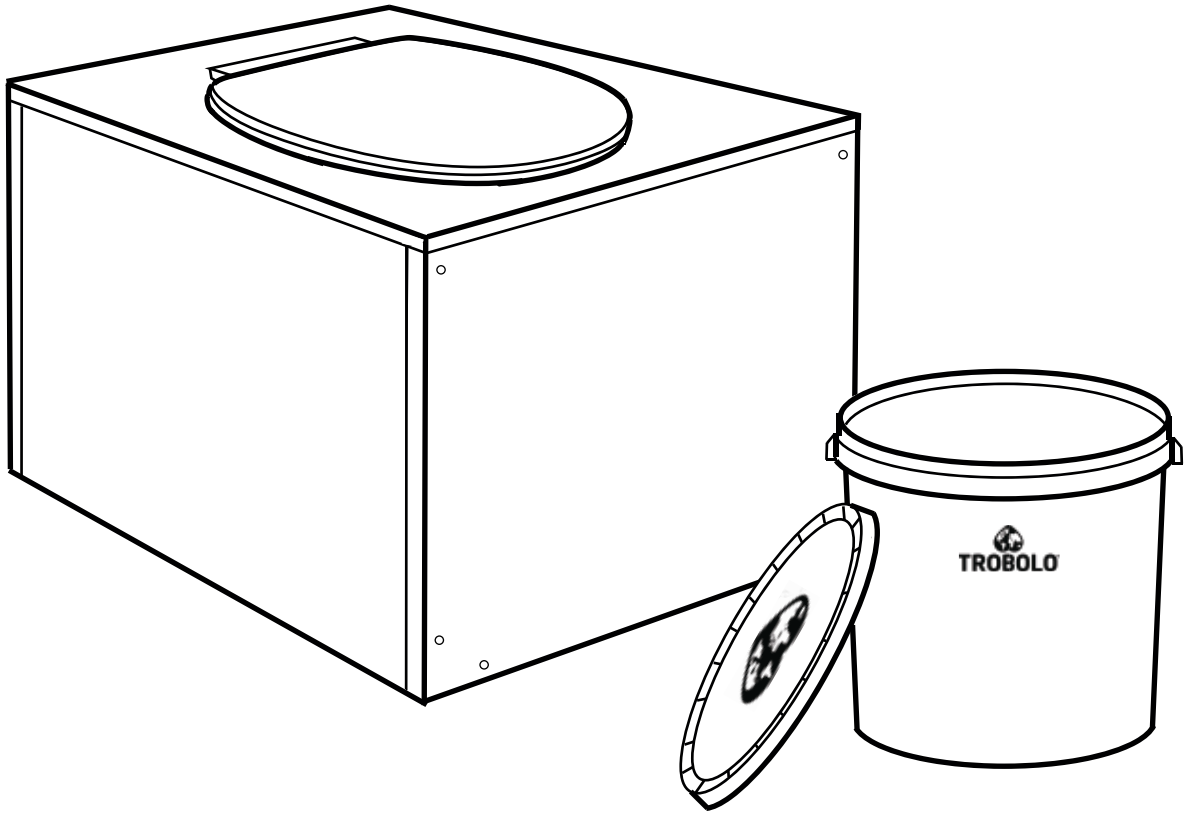

3 V1

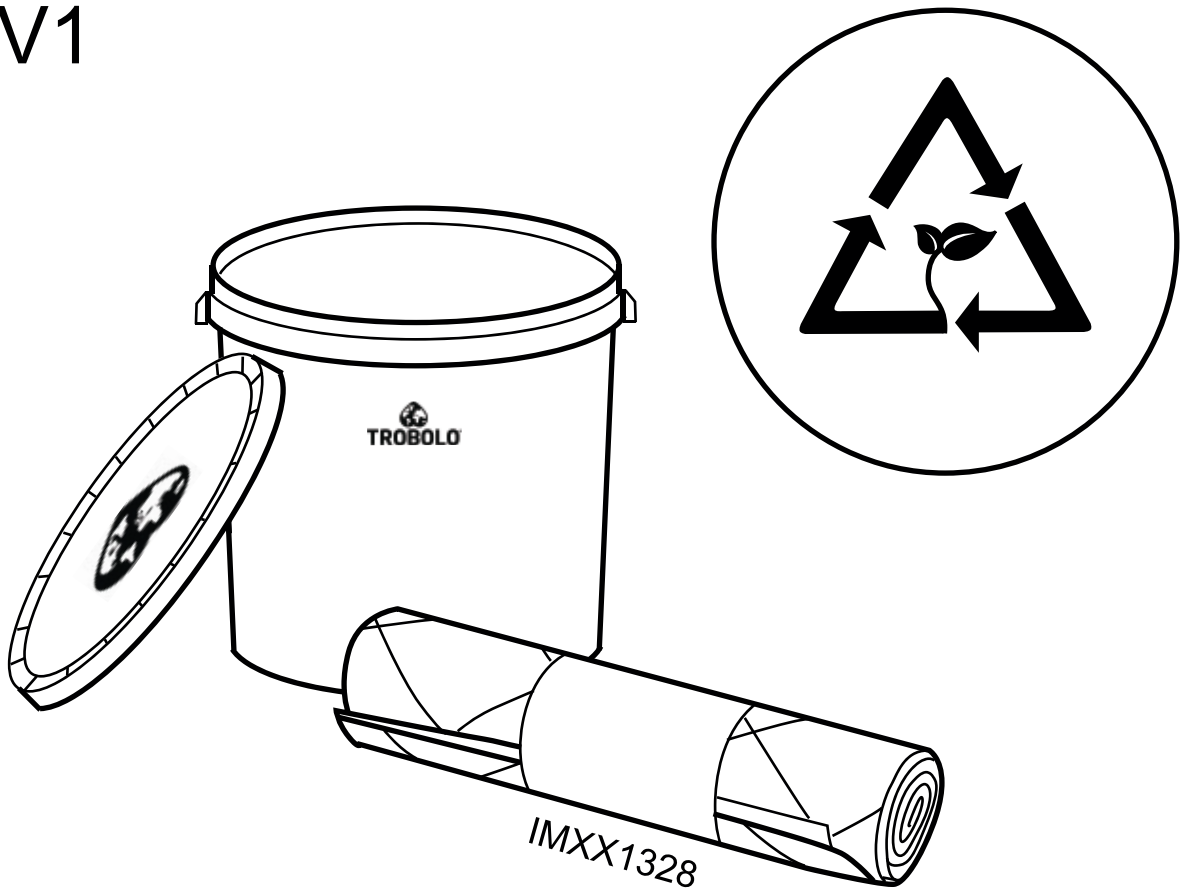

3 V2

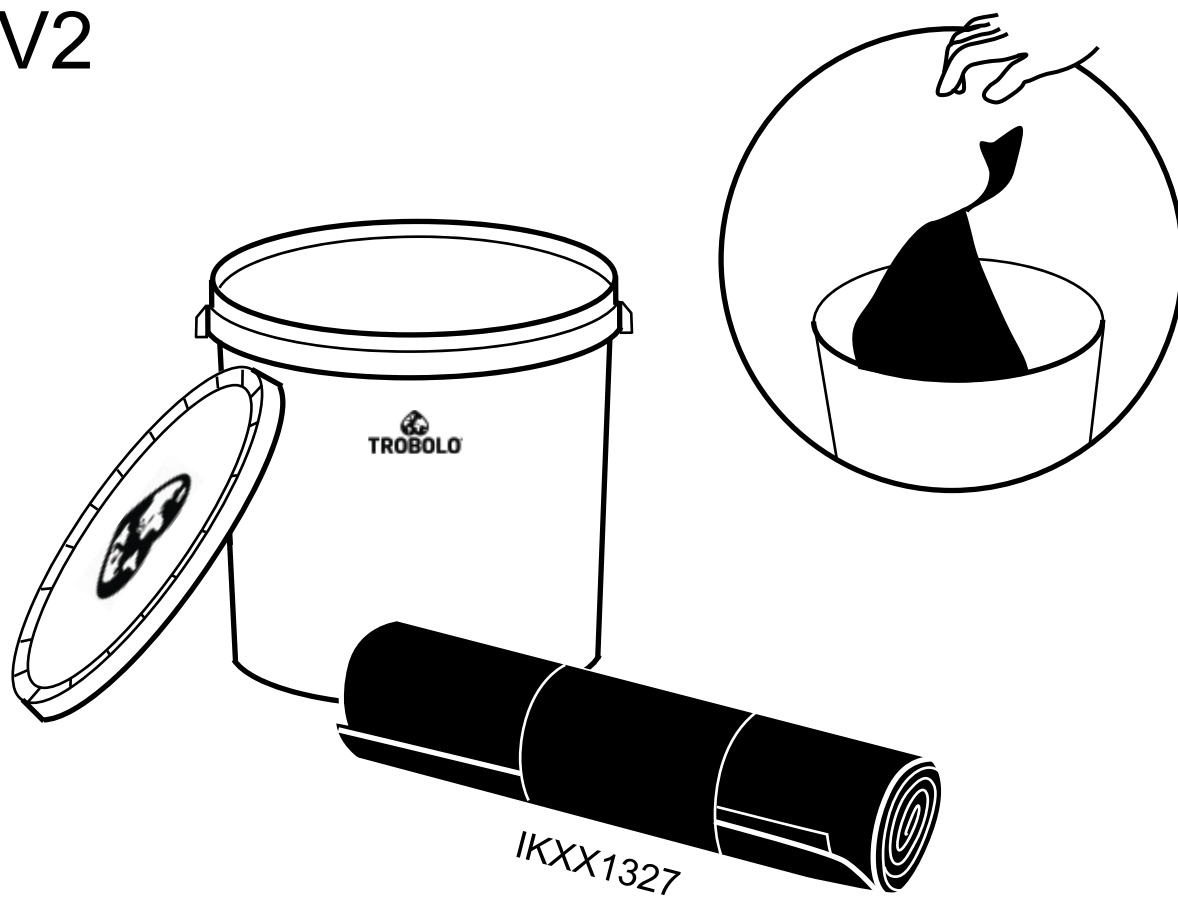

4

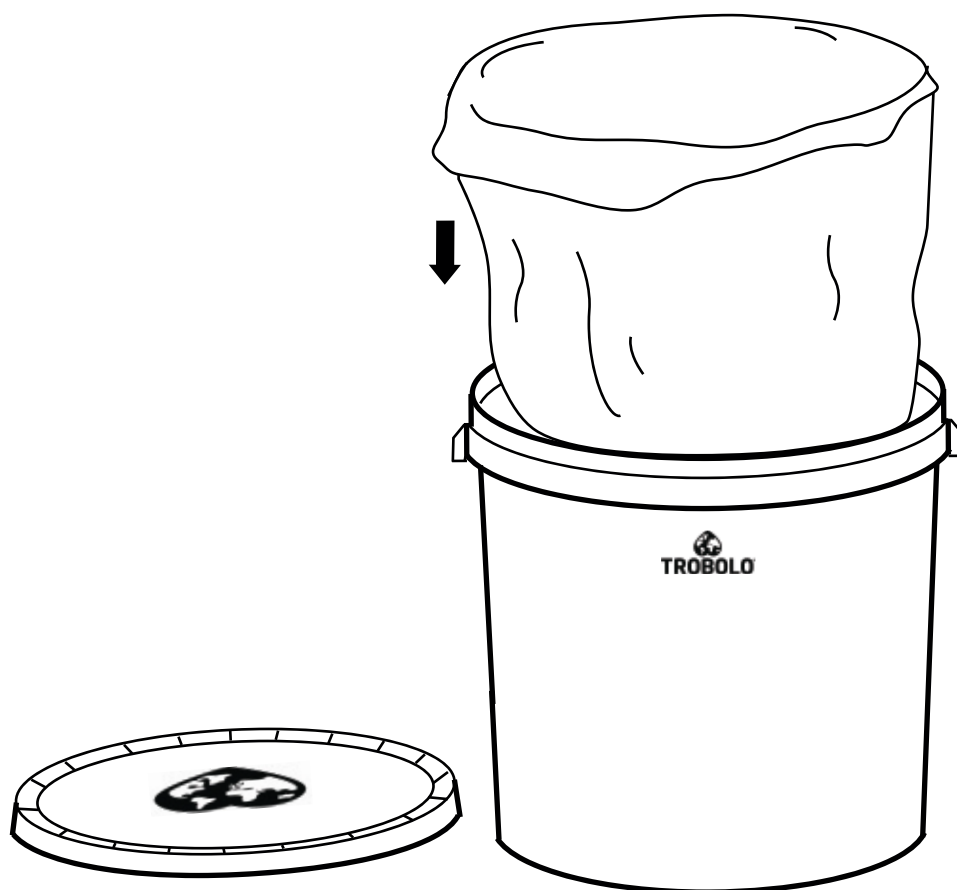

5

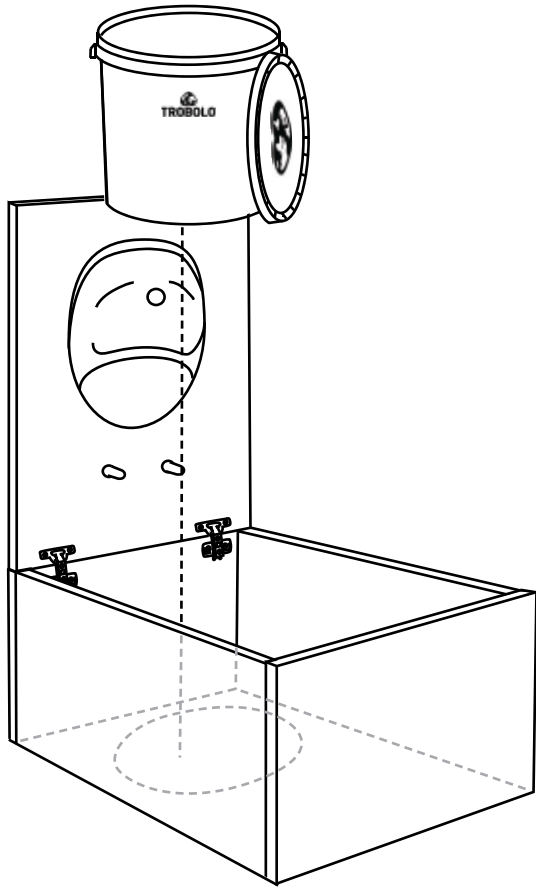

Use

Nutzung / Utilisation

1

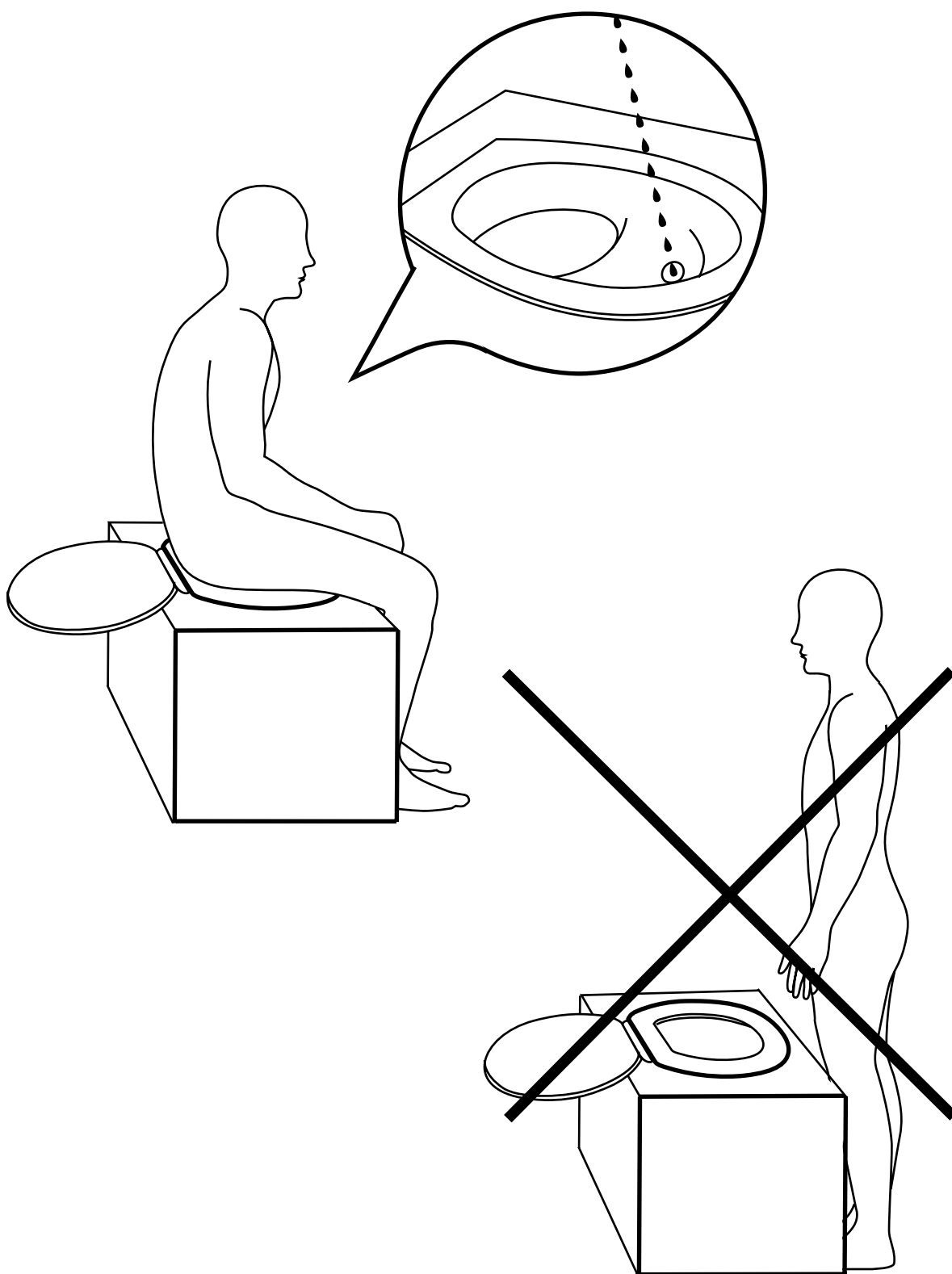

2

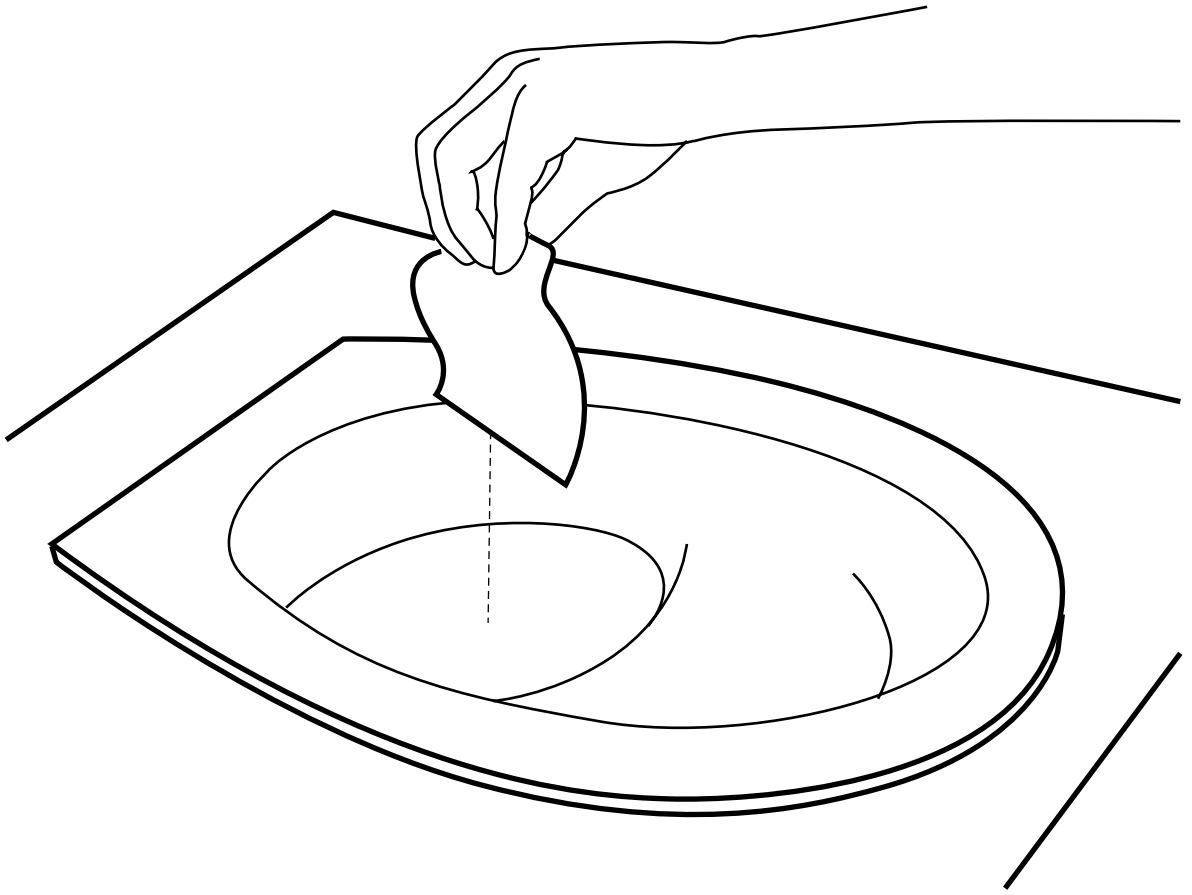

3

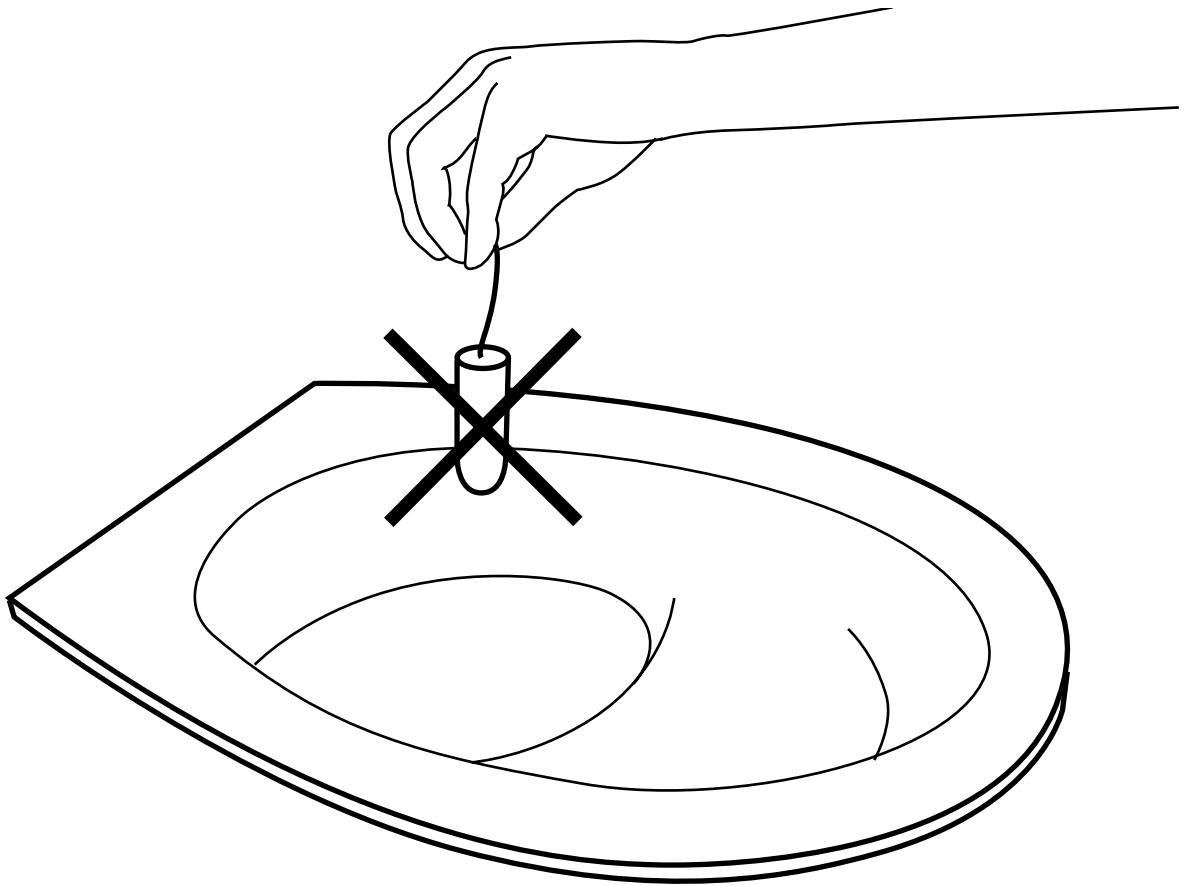

Emptying

Entleerung / Vidange

1

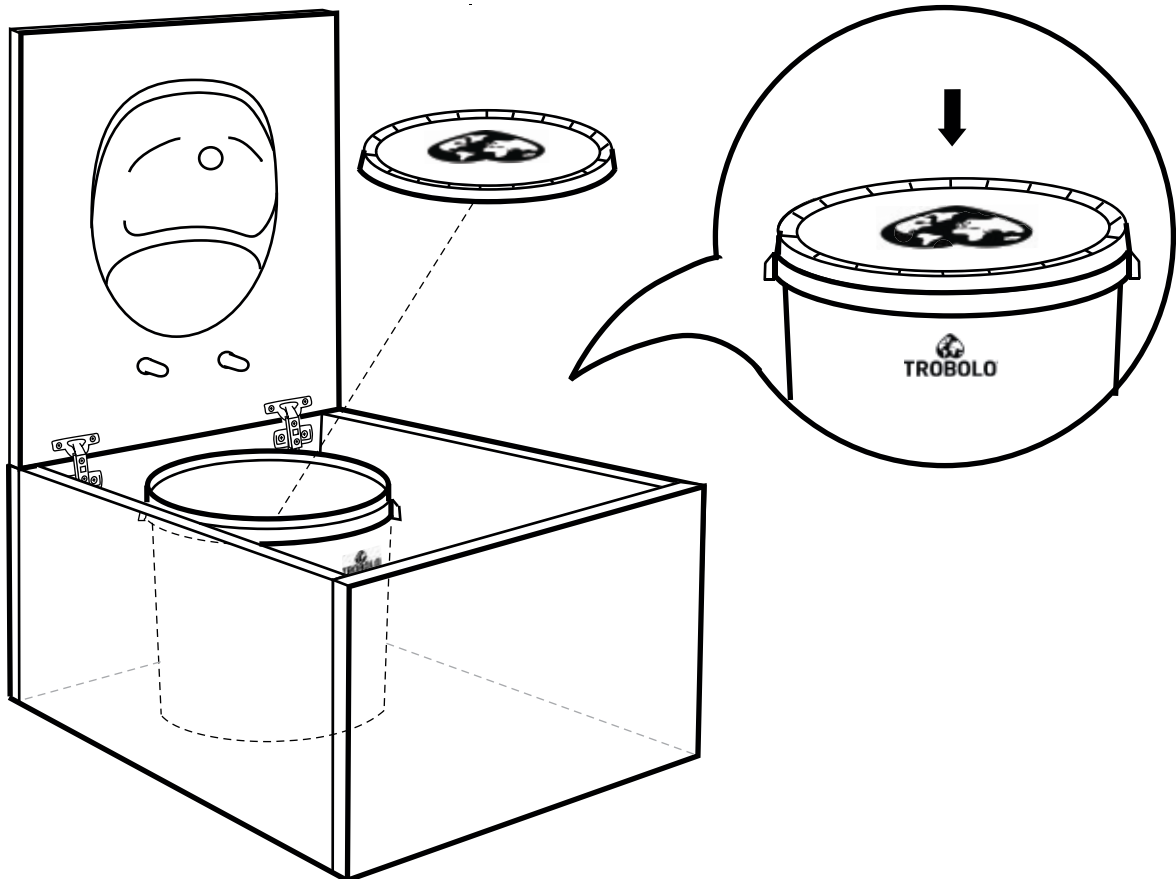

2

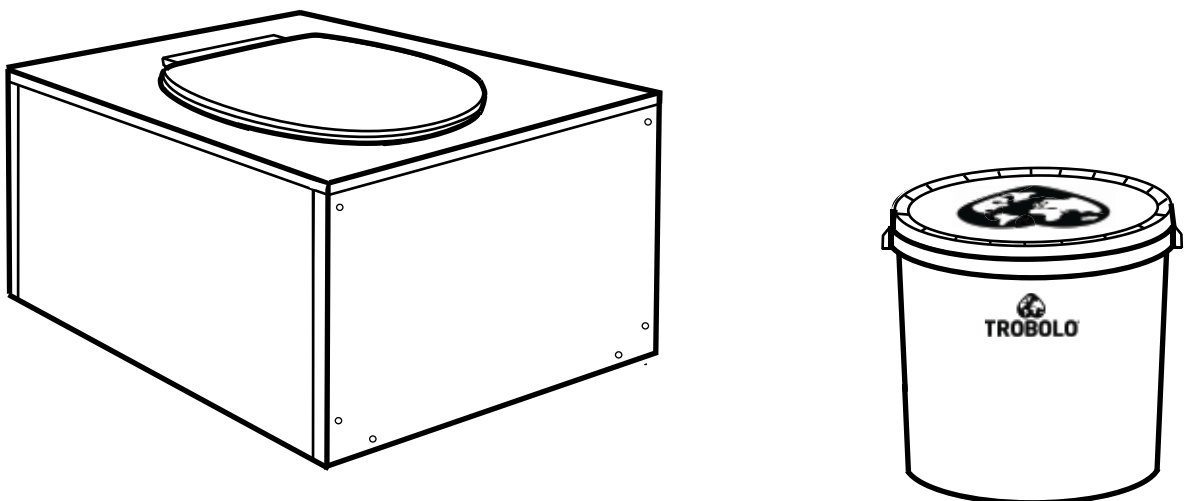

3 V1

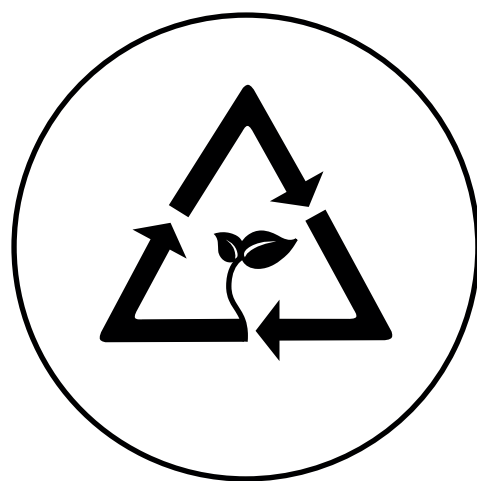
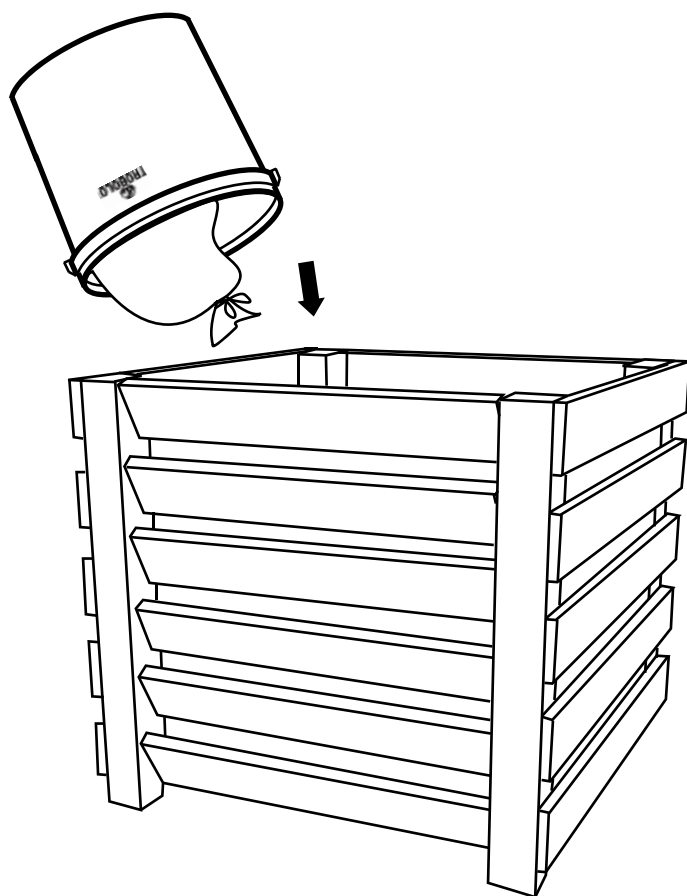
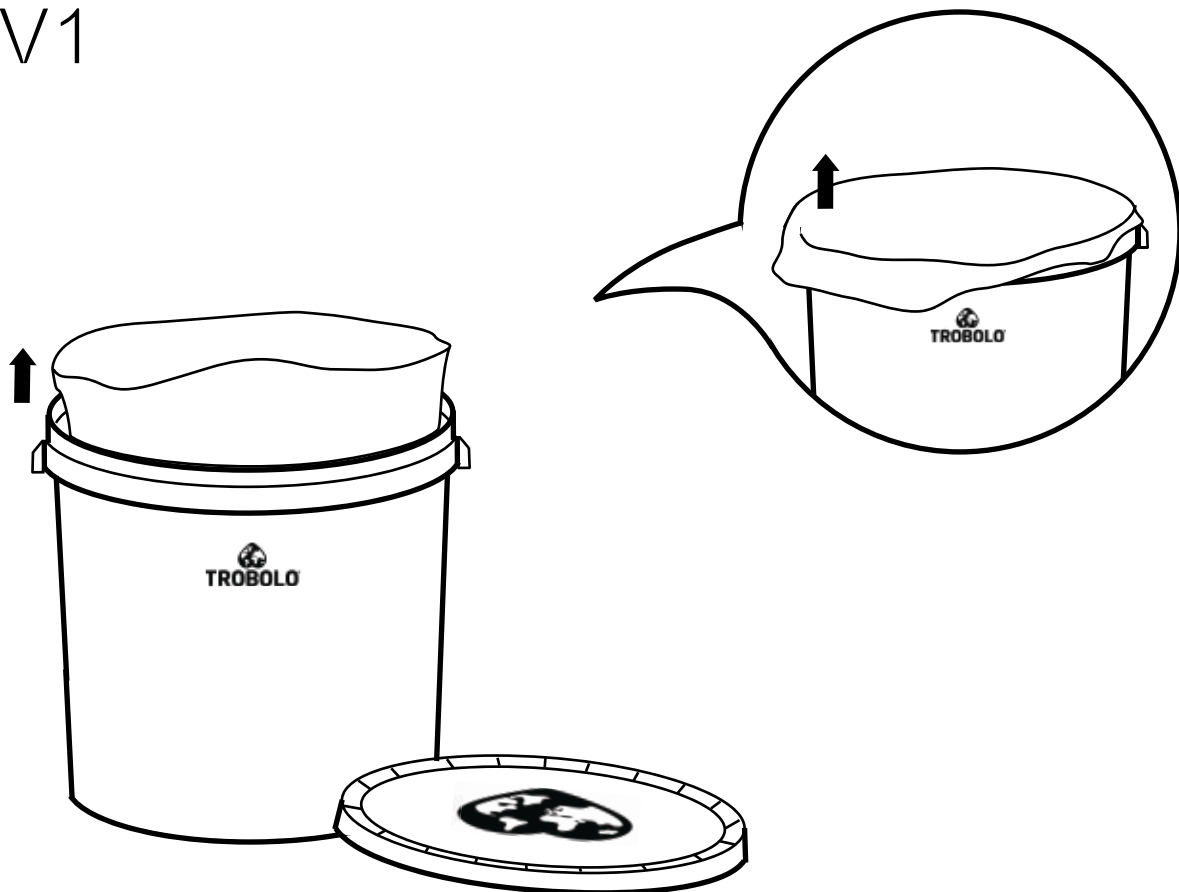

4 V2

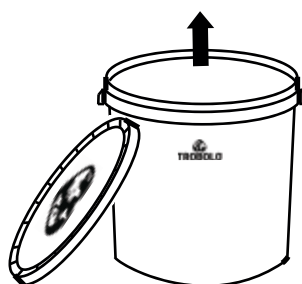
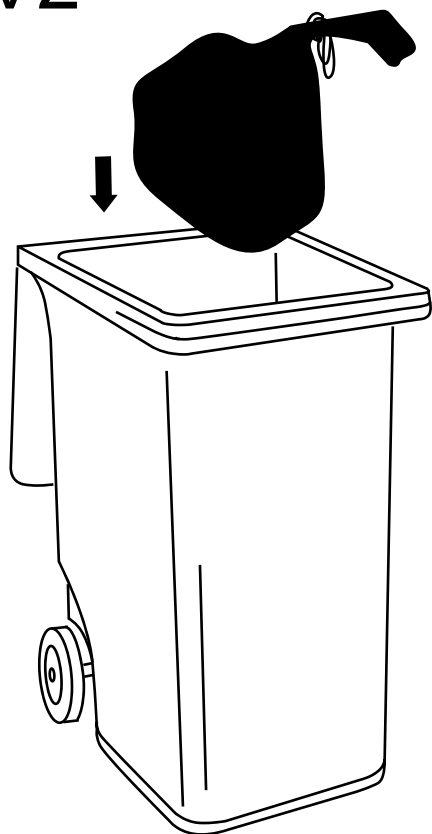

Cleaning

Reinigung / Nettoyage

1

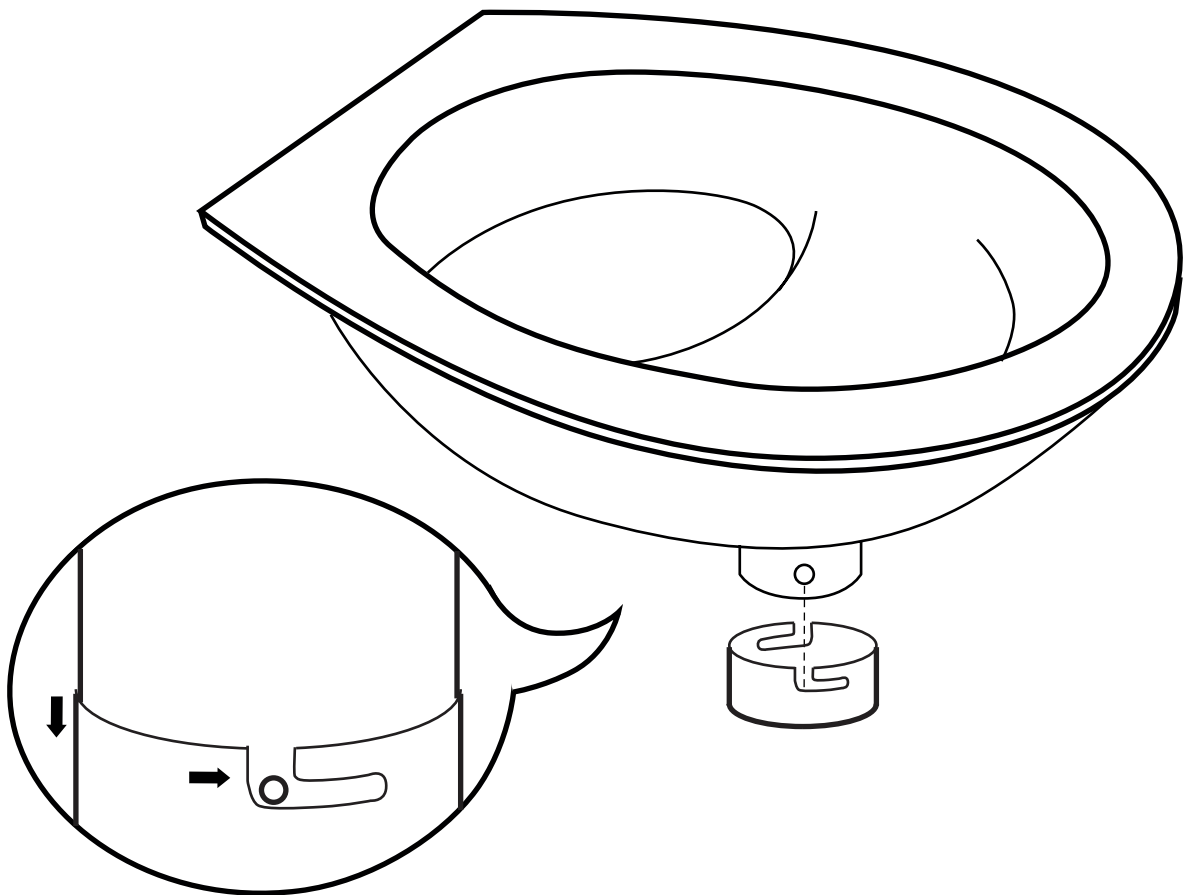

2

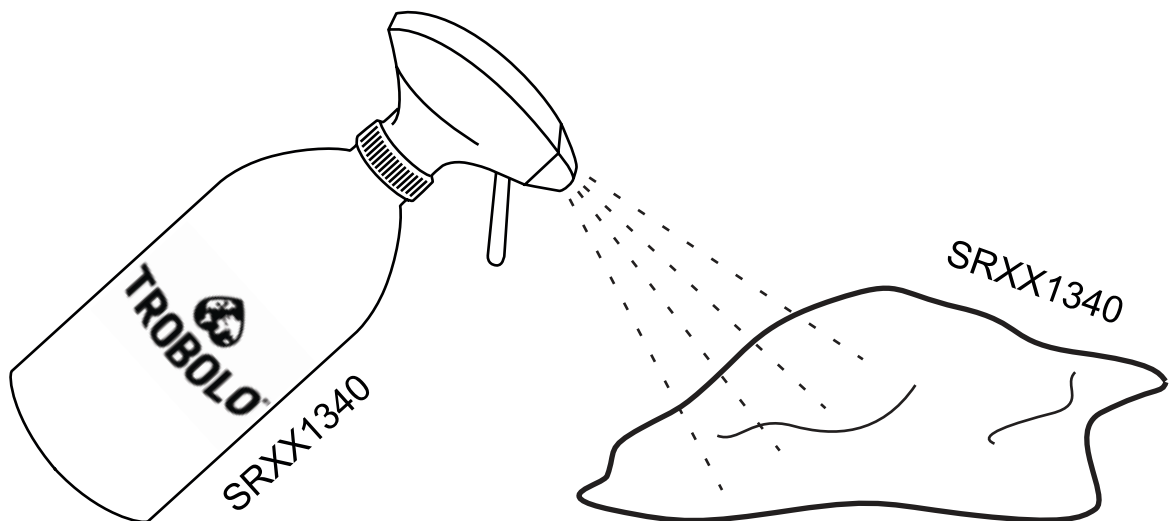

3

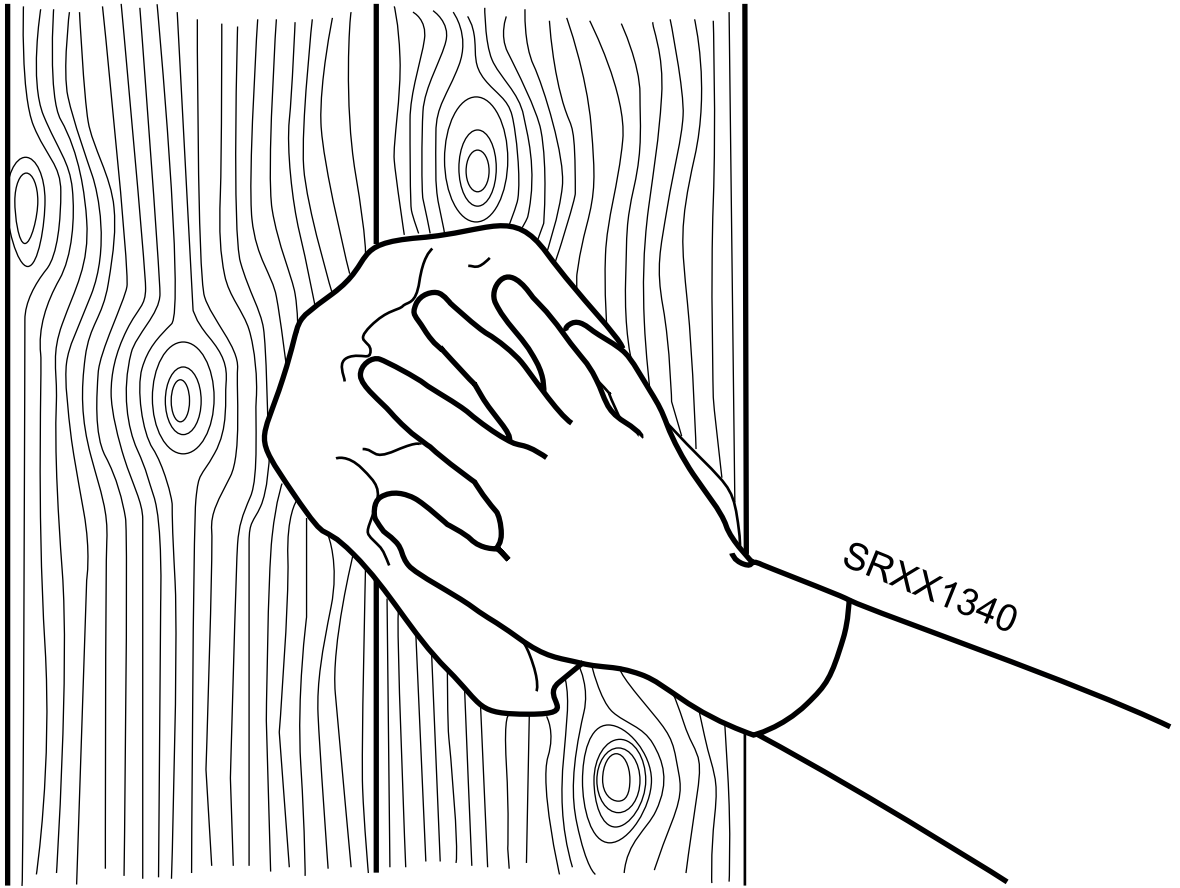

4

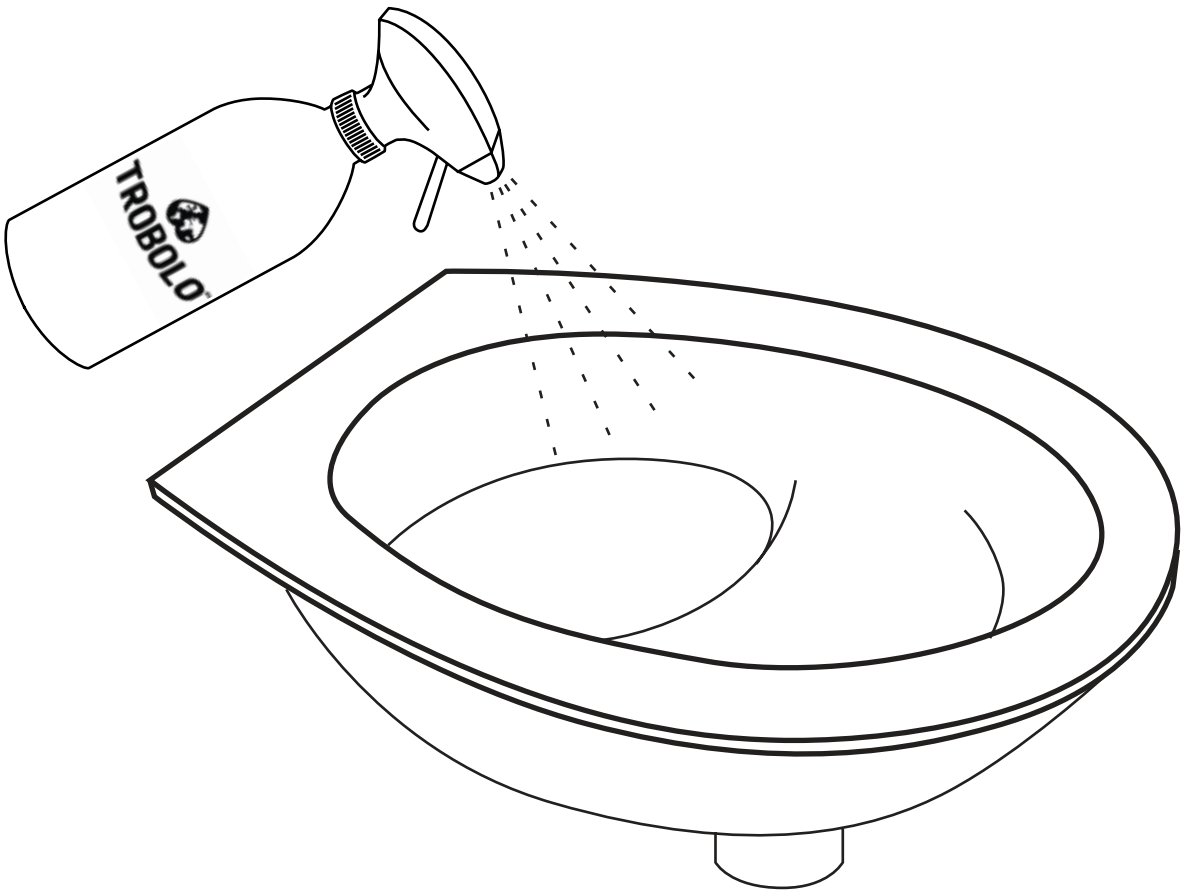

5

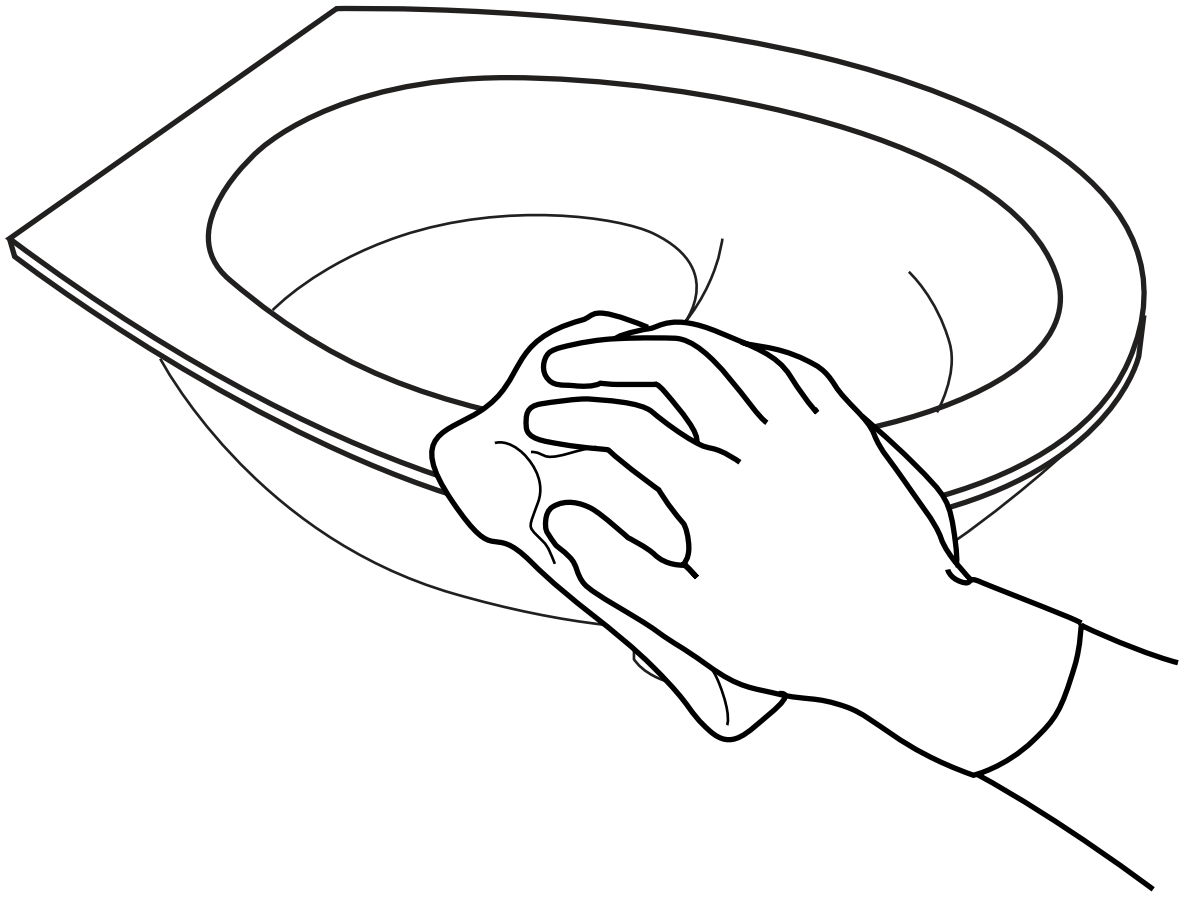

6

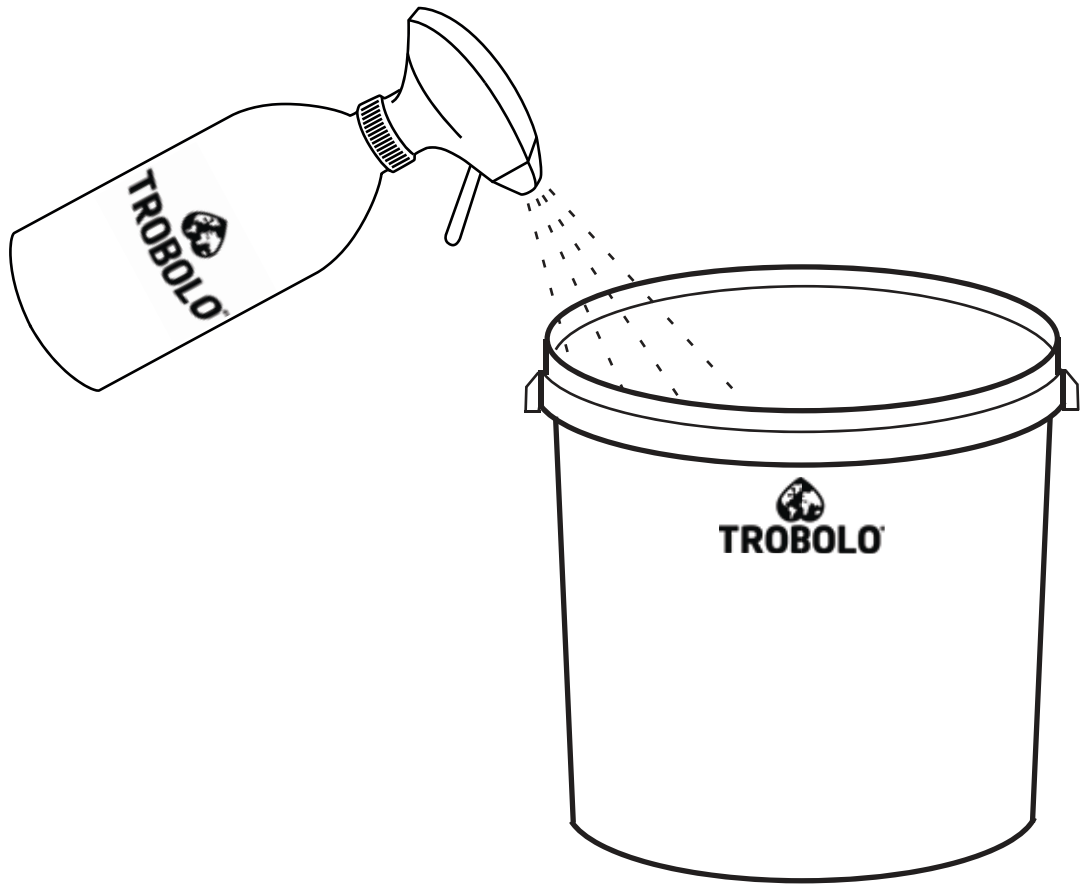

7

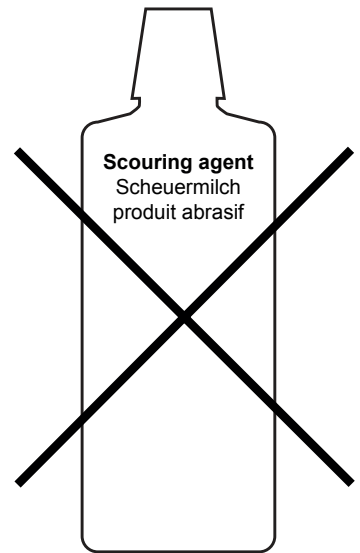
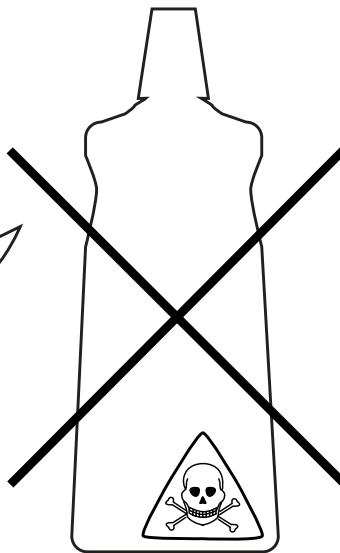
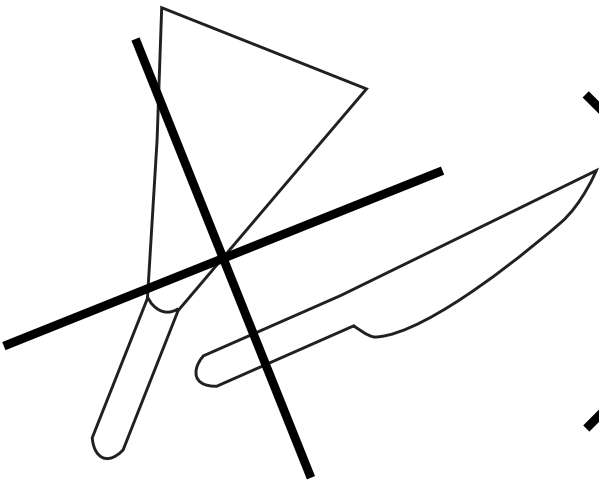

Technical data

Technische Daten / Données techniques

Fan / Lüfter / Ventilateur

Noise level 19,3 dB

Geräusentwicklung / Niveau sonore

Max. power consumption 1,3 W

Max. Leistungsaufnahme / Puissance max.

Max. current 0,26 A

Max. Stromstärke / Courant max.



TROBOLO®

Designed in Germany.
Manufactured in Europe.

www.trobolo.com