

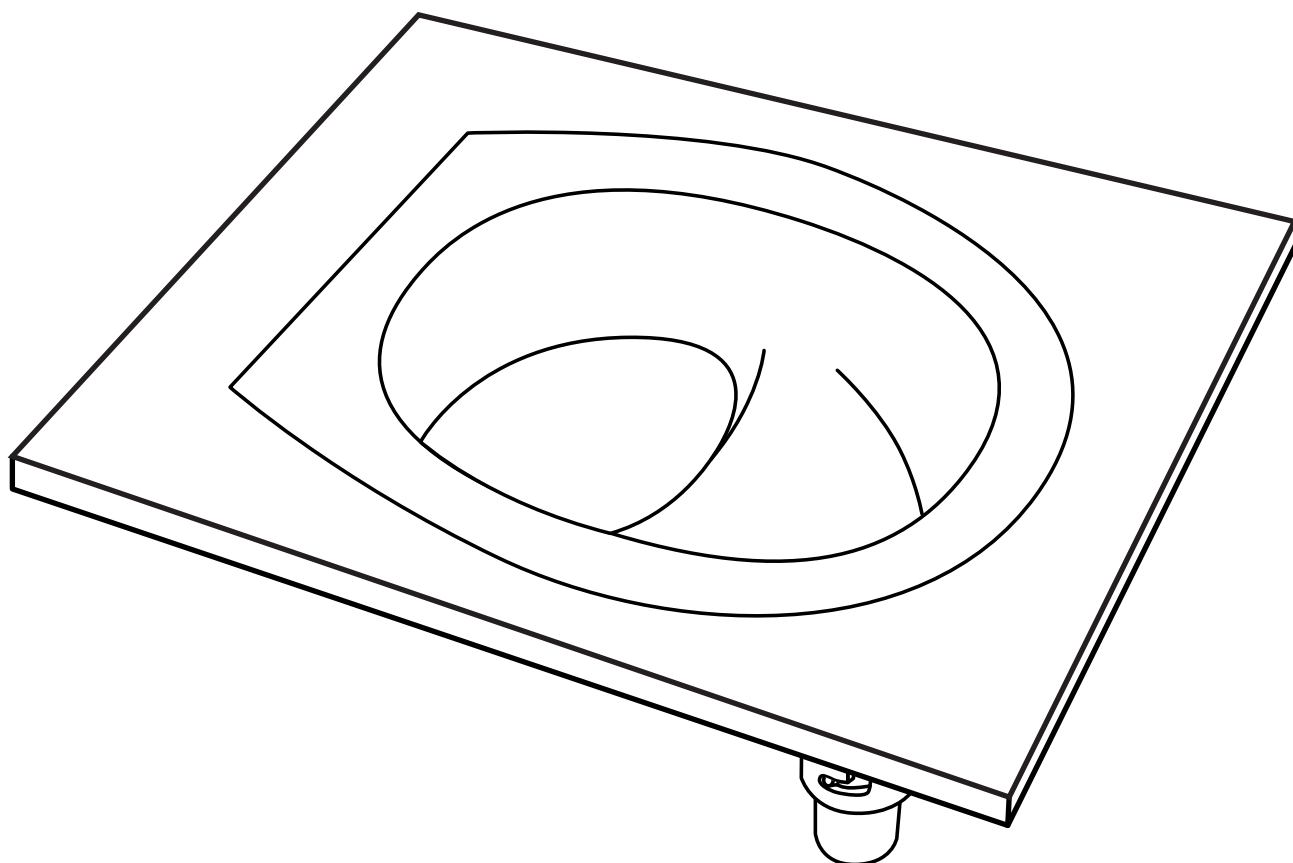

TROBOLO®



MAN.U6XX1363.2

1

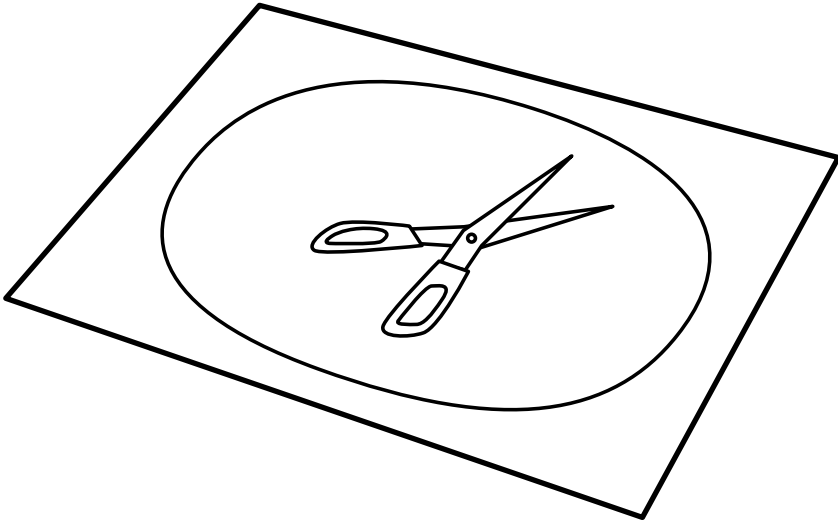

2

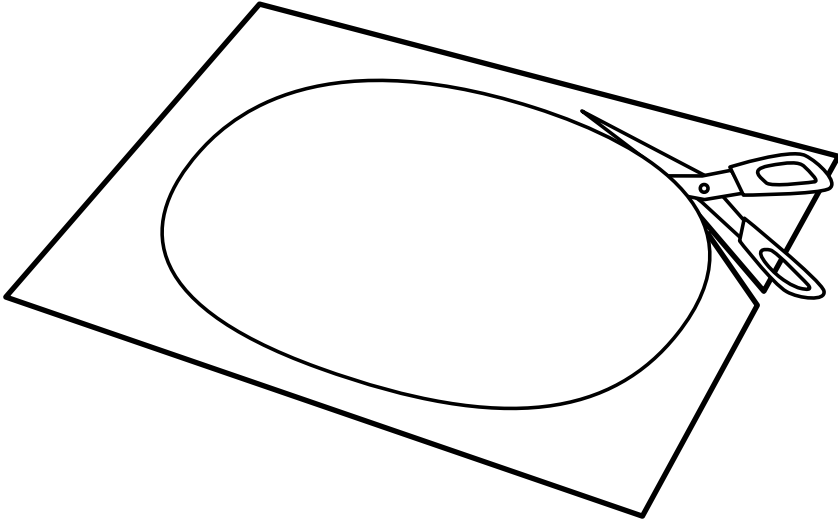

3

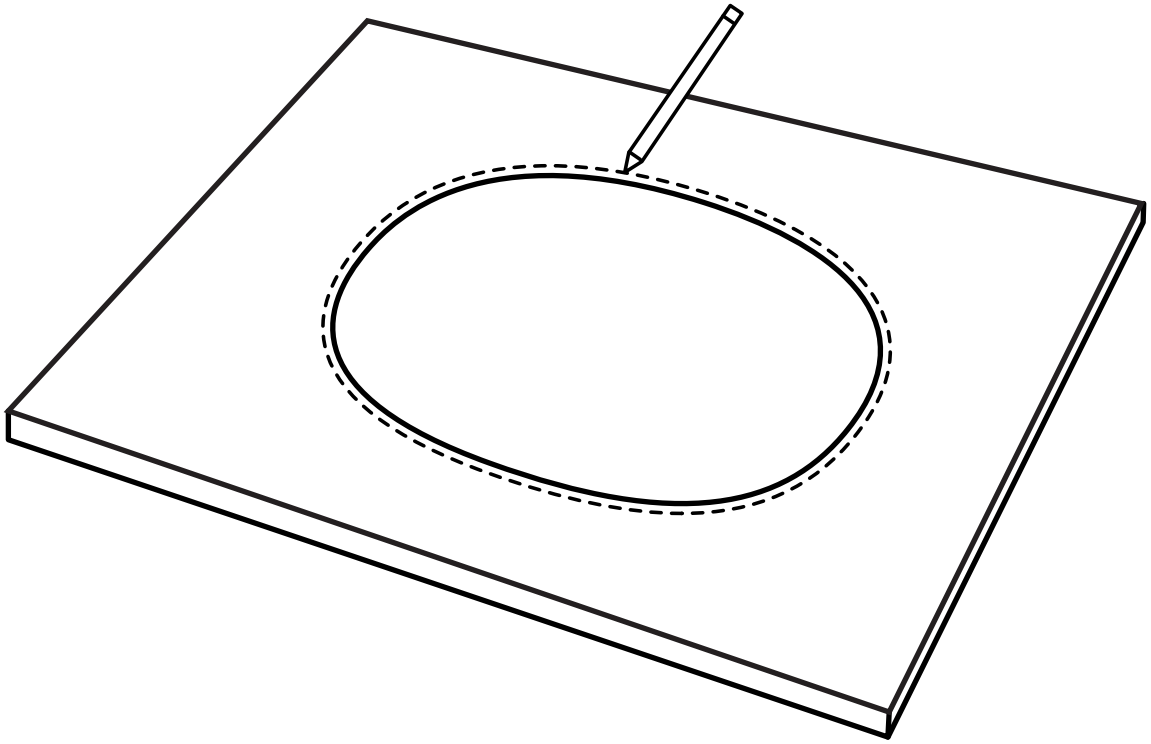

4

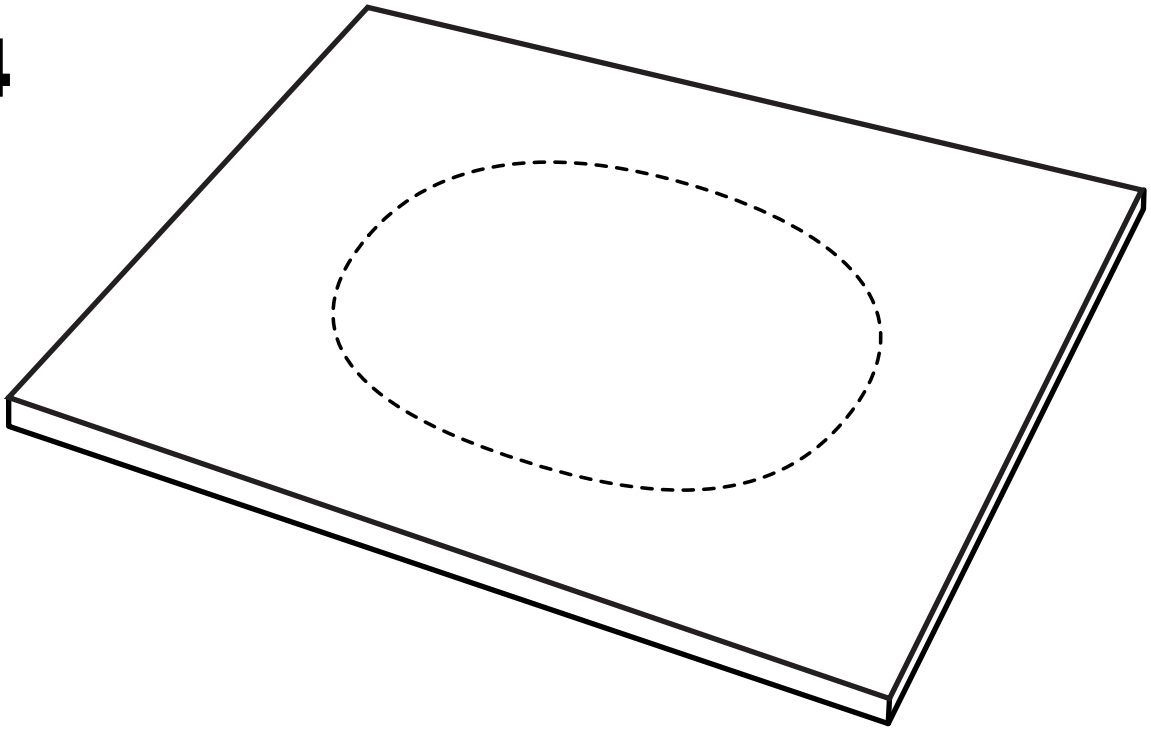

5

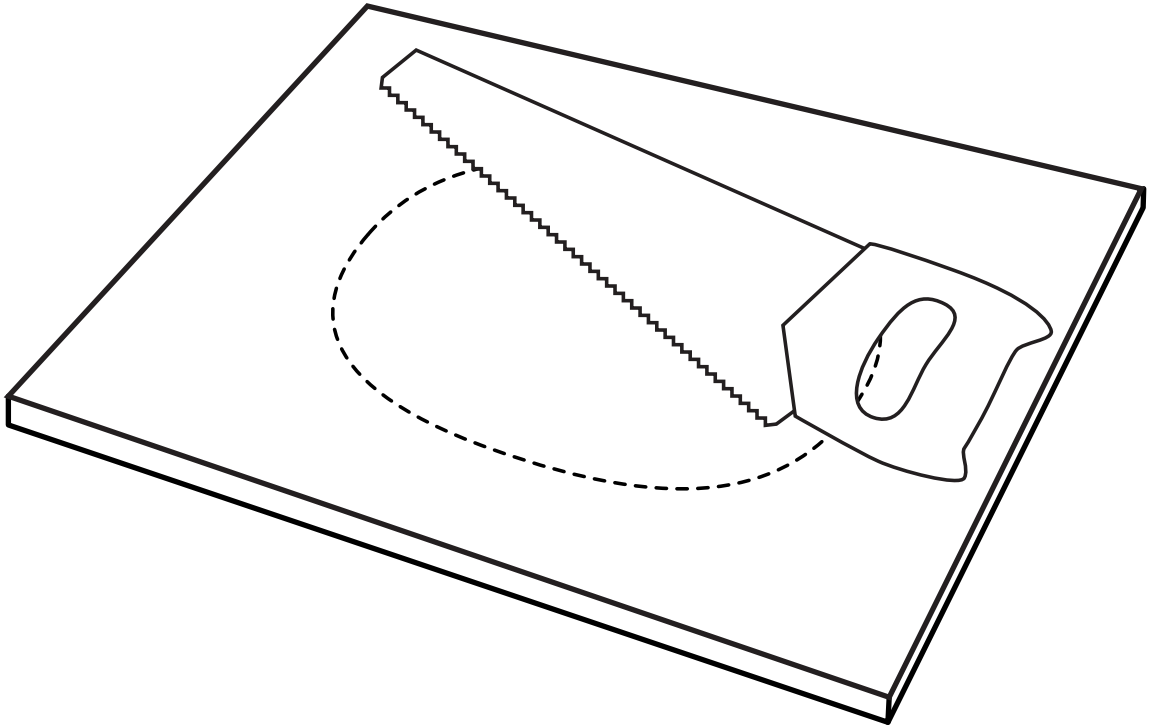

6

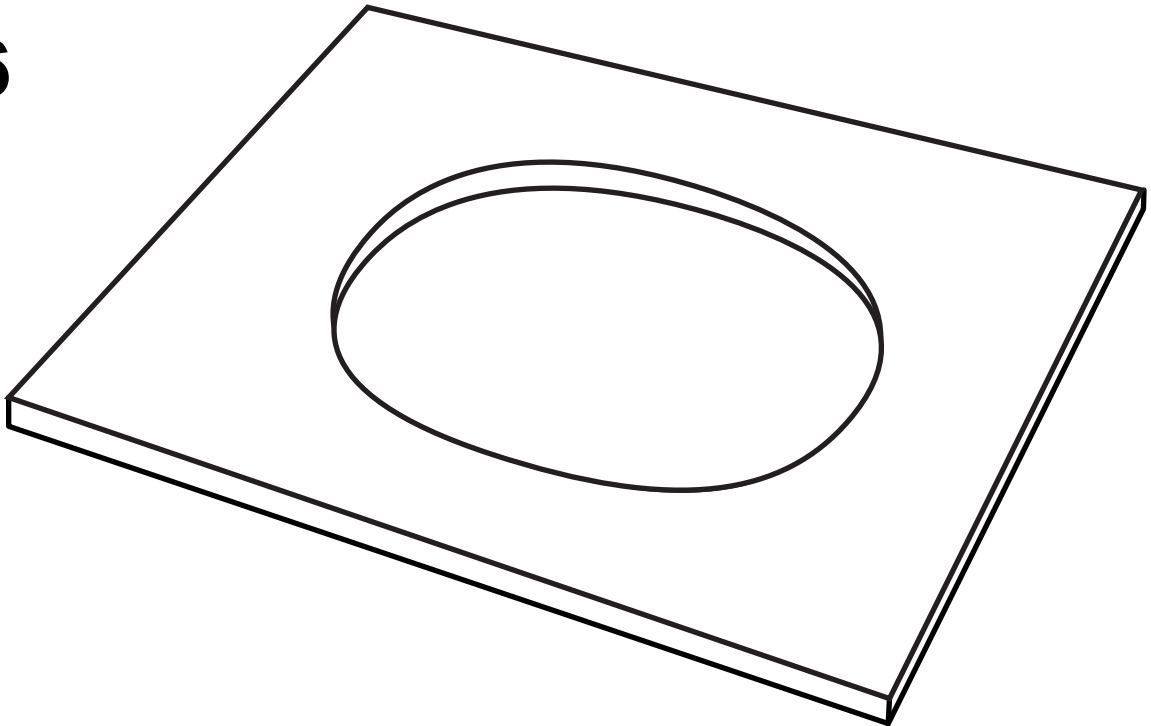

7 V1

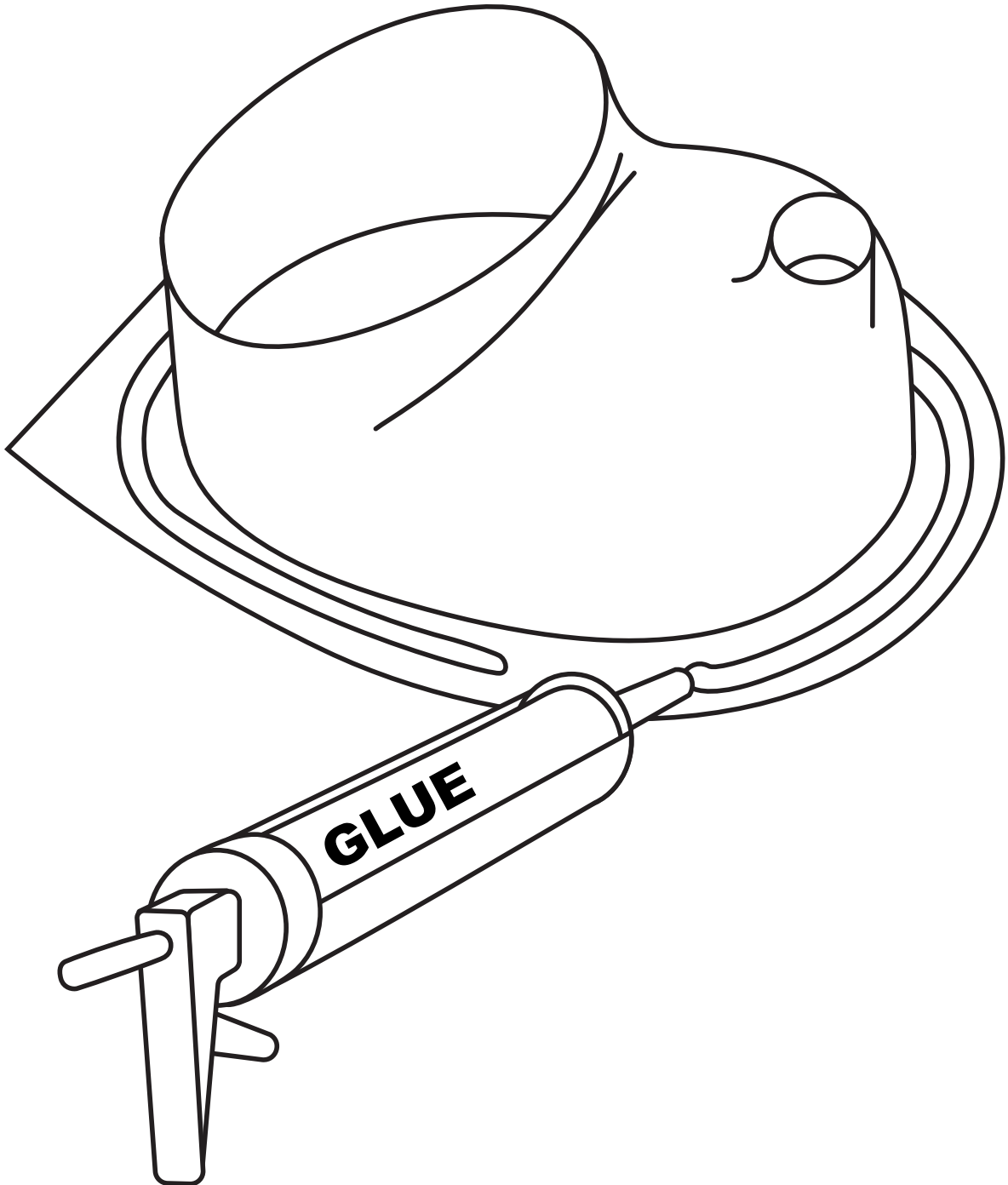

7 V2

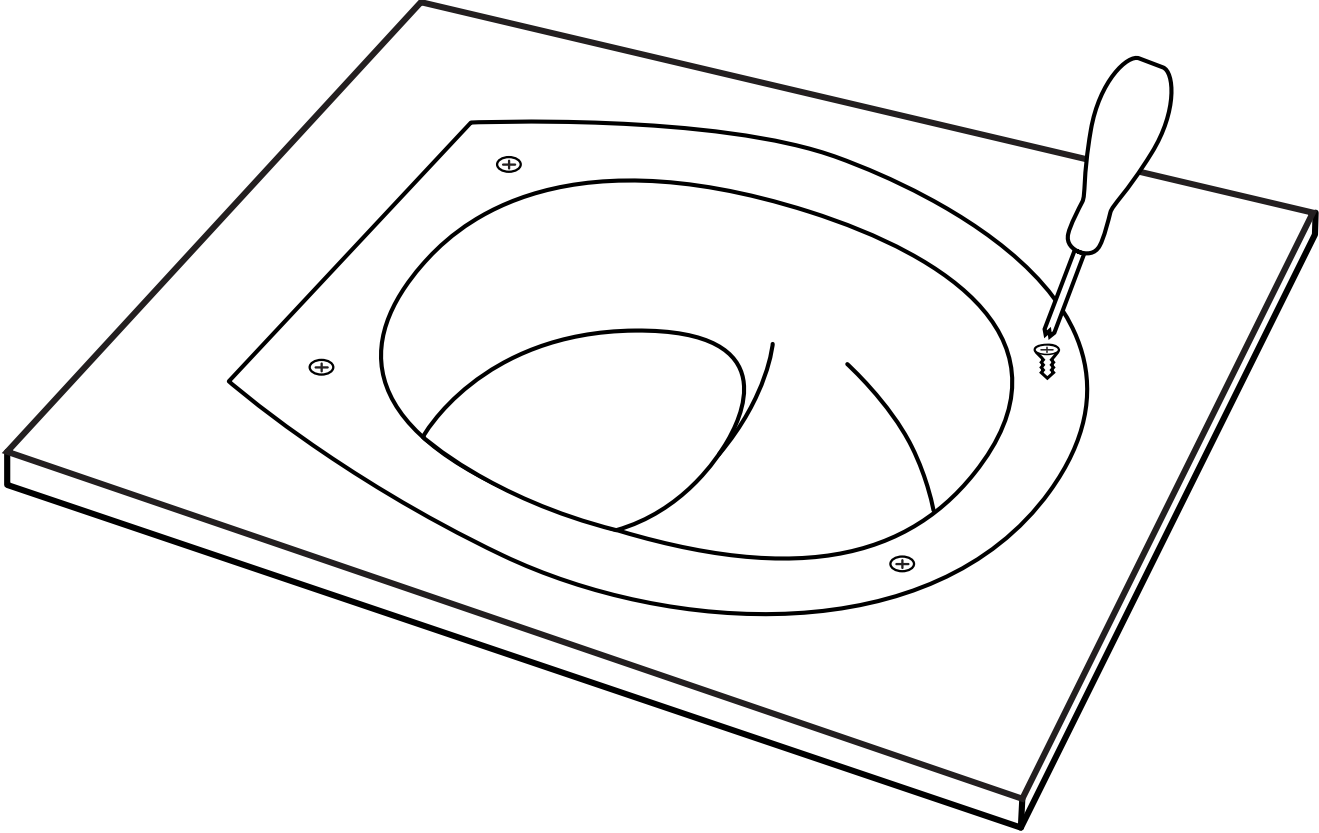
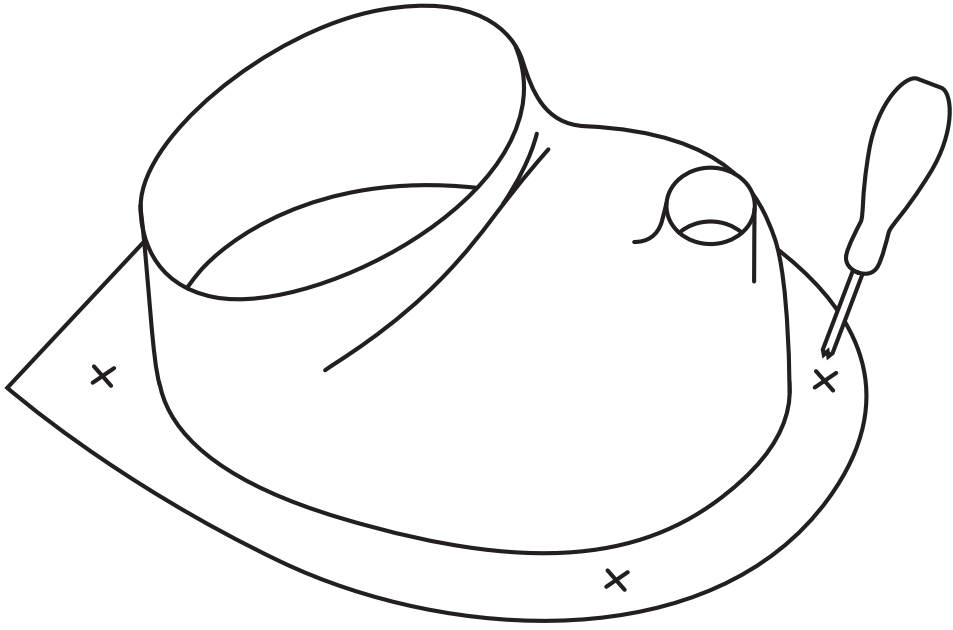

8

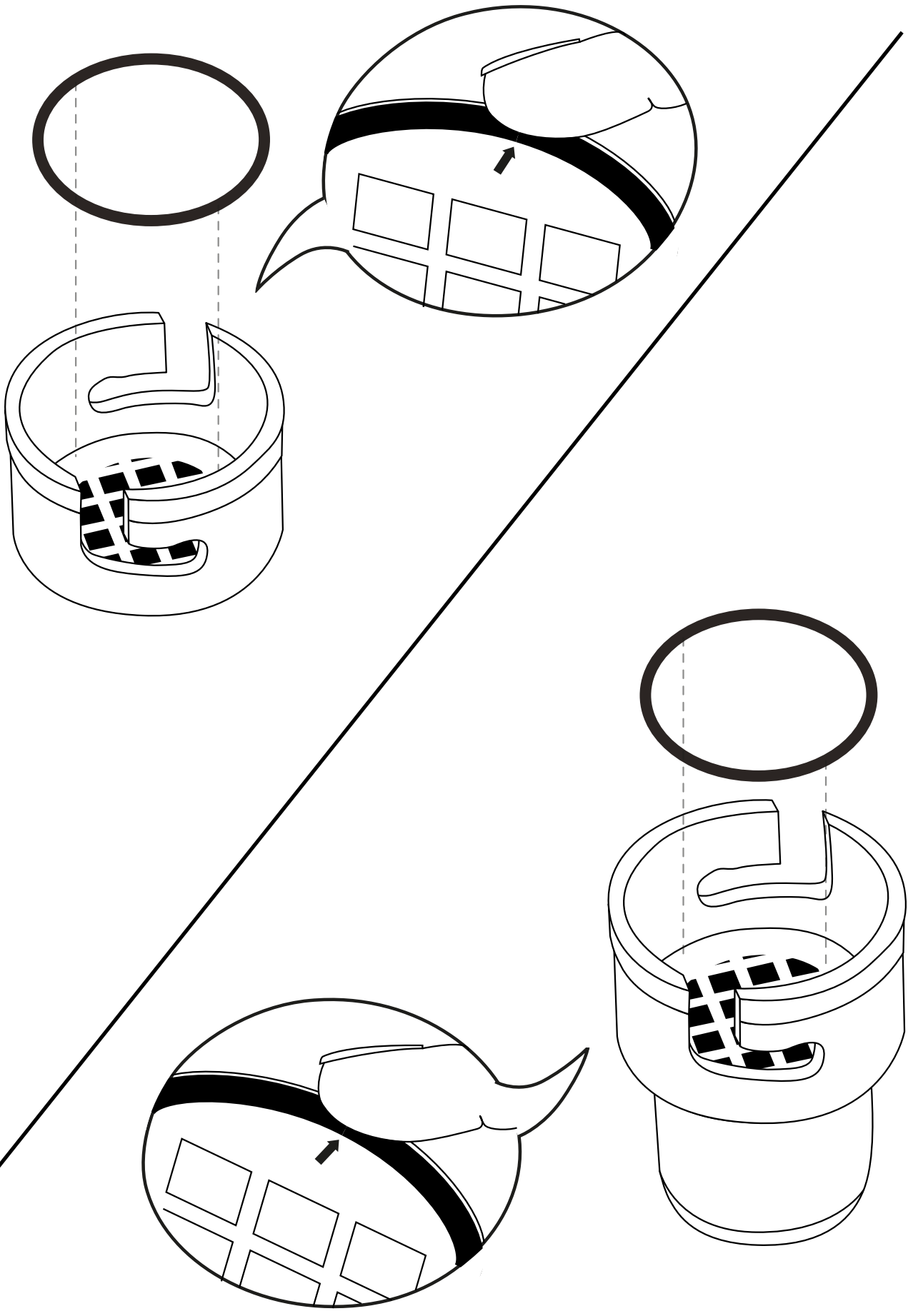

9

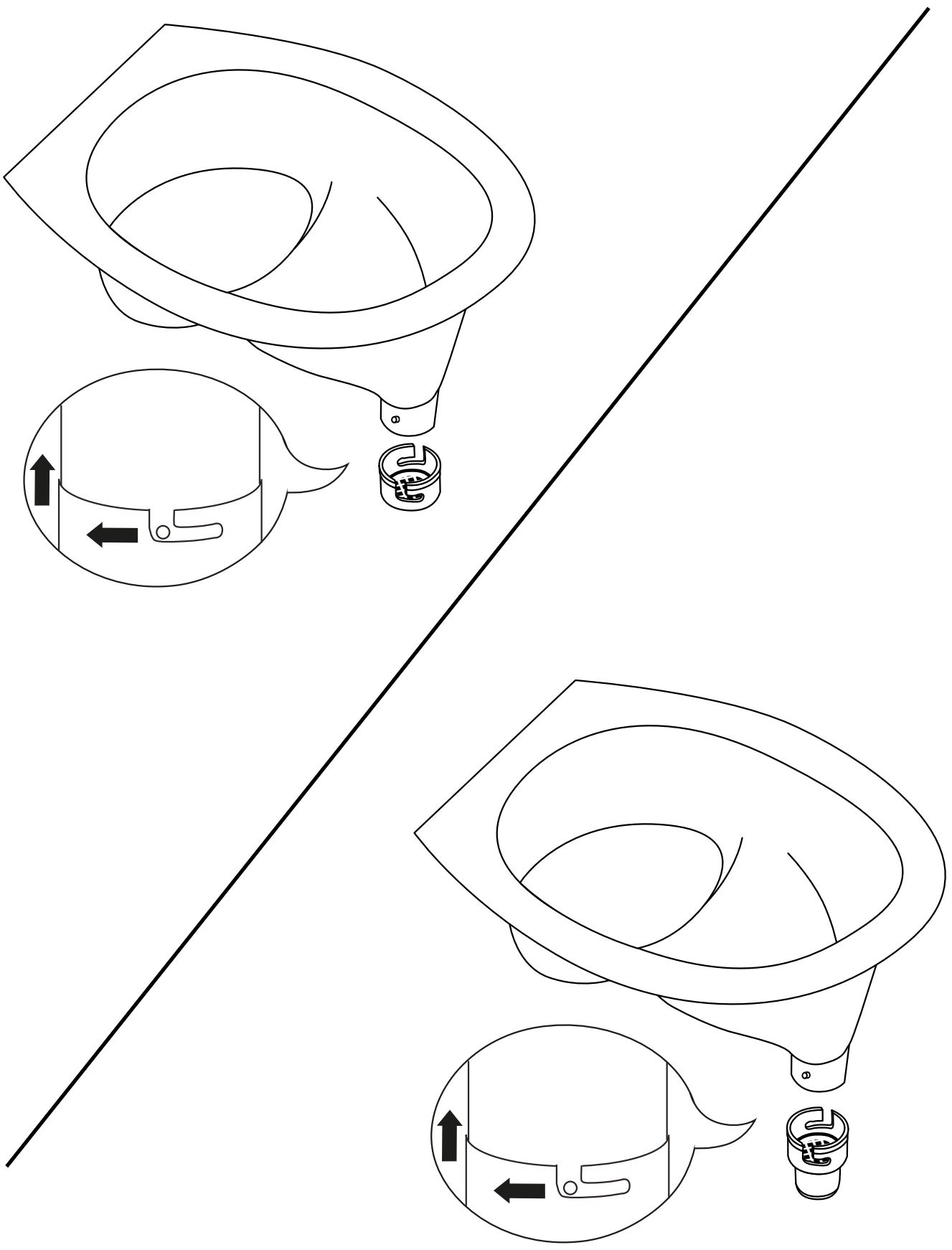

10

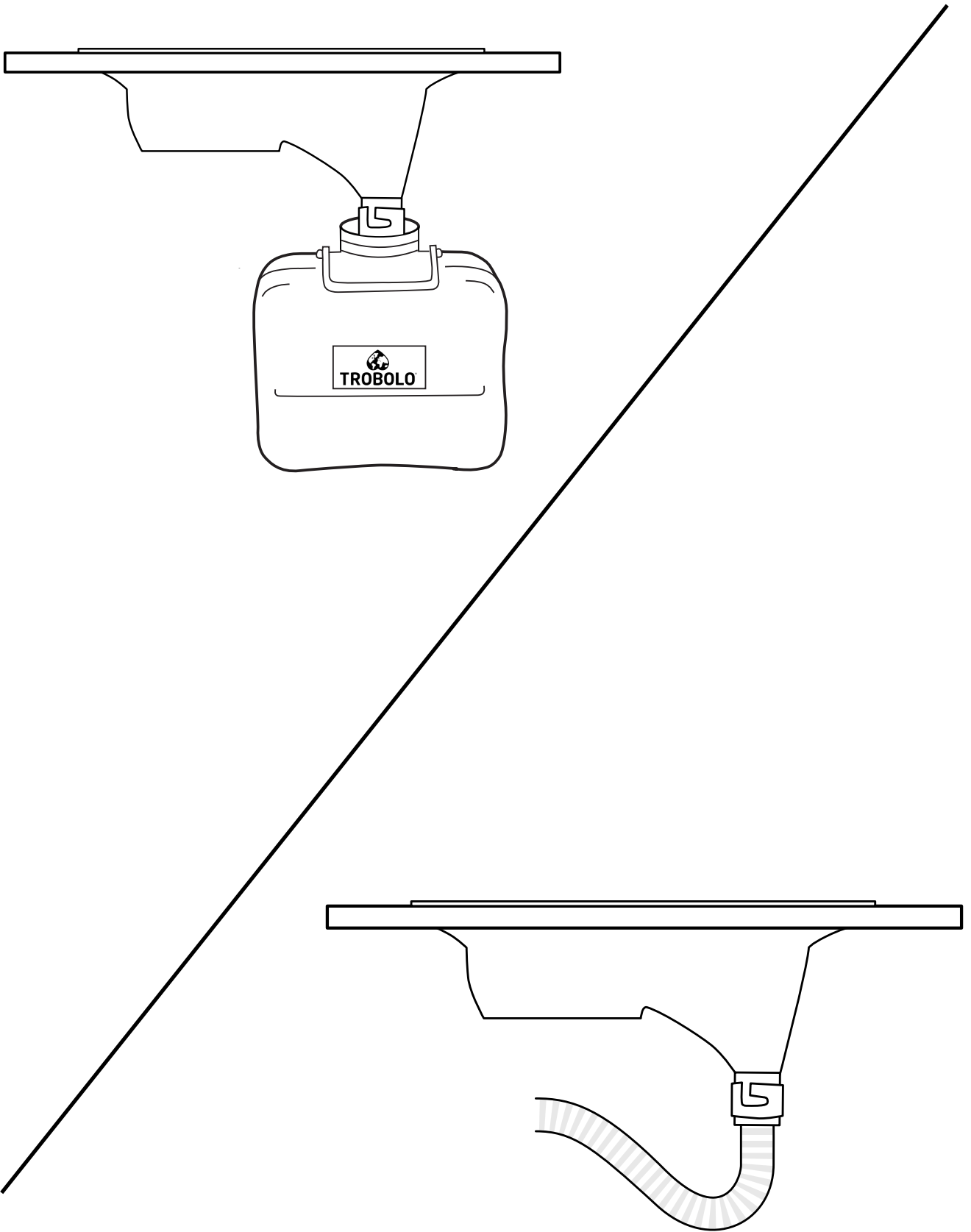



TROBOLO®

Designed in Germany.
Manufactured in Europe.

www.trobolo.com